

ATEX DISTRIBUTION BOX

16A | 220V | 2 Way

Description:

Compact and Ex-marked, this Distribution Box is designed for safe use in Zones 1 & 2 (Gas) and 21 & 22 (Dust). It powers LED lights and tools efficiently, reducing cable clutter. The GRP (Glass Reinforced Plastic) body ensures strength and durability. Certified for hazardous areas, it provides safe and reliable power distribution.

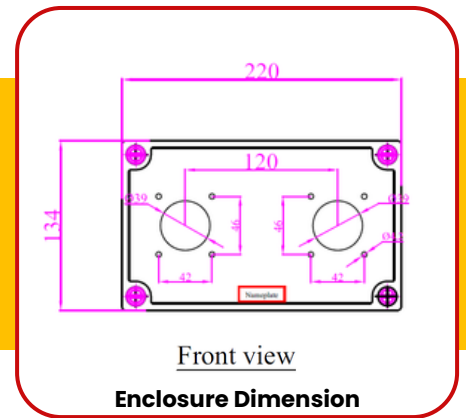
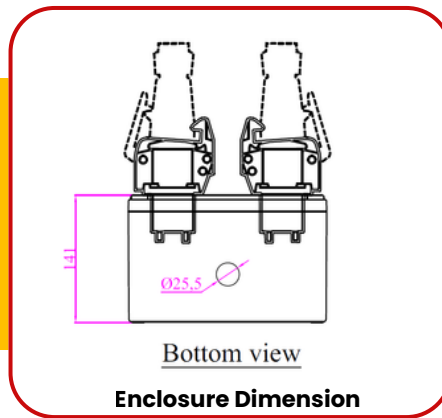

Applications:

- Hazardous area maintenance and shutdown operations
- Oil & gas facilities, offshore platforms
- Petrochemical plants and refineries
- Confined space lighting and power distribution
- Tunnels, tanks, and industrial inspection zones
- Mobile power supply for Zone-classified sites

Technical Data

Parameter	Specification
Ex Mark	Ex eb IIC T4 Gb; Ex tb IIIC T130°C Db
Certification	ATEX (EU) IECEx (International) CCC (China)
Inlet	16A 220V Male Plug
Outlet	16A 220V Flush Socket - 2 Nos
Intended Use	Zone 1 Explosive Gas & Zone 21 Dust
Ambient Temperature	-40°C to + 50°C
Protection	IP66
Zone Compatibility	2G/ Zone 1 2D/ Zone 21
Enclosure	GRP Box
Plug and Socket Option	Appleton Atkon Ceag CZ
Cable Option	SY Braided Cable Rubber Cable
Cable Entry Gland	M25

